

Фасадная серия RF 50

Стойки

RE 6005  
lx=674,53cm

RE 6006  
lx=895,64cm

RE 6010  
lx=1288,5cm

RE 6017  
lx=2172,33cm

RE 6000  
lx=40,15cm

RE 6001  
lx=86,35cm

RE 6402  
lx=119,92cm

RE 6002  
lx=144,19cm

RE 6003  
lx=261,8cm

RE 6404  
lx=339,43cm

RE 6004  
lx=400,57cm

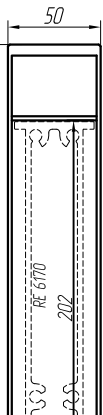
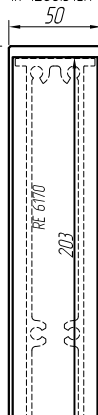
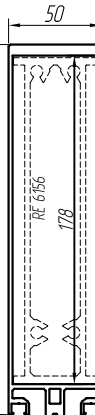
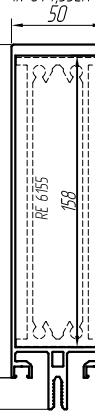
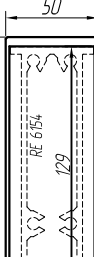
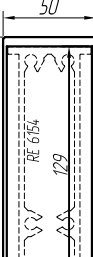
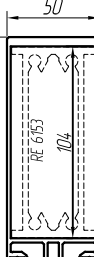
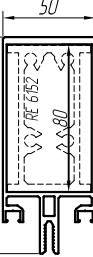
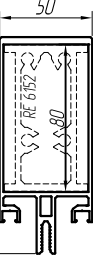
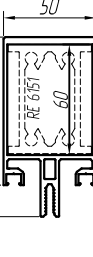
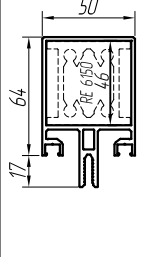

RE 6028  
lx=476,37cm

RE 6027  
lx=308,88cm

RE 6026  
lx=190,42cm

RE 6025  
lx=113,9cm

RE 6206  
lx=103,03cm

Ригели 1-ого уровня

RE 6024  
lx=69,06cm

RE 6205  
lx=62,61cm

RE 6023  
lx=42,46cm

RE 6201  
lx=38,47cm

RE 6022  
lx=16,05cm

RE 6200  
lx=14,32cm

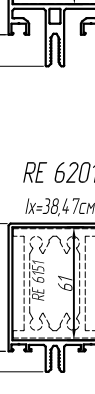
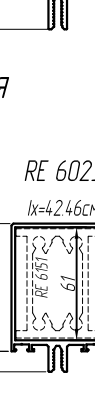
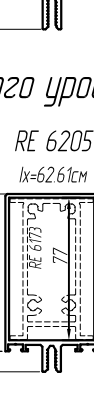
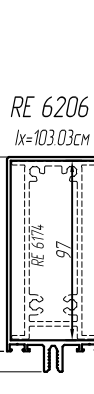
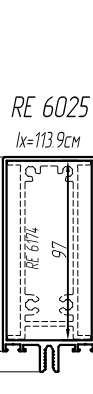
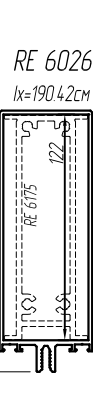
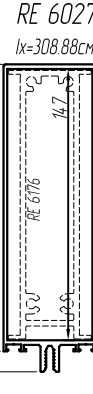
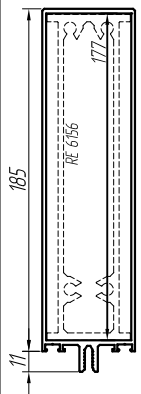

Ригели 2-ого уровня

Ригели 1-ого уровня

RE 6033  
lx=301,07cm

RE 6032  
lx=183,99cm

RE 6204  
lx=142,93cm

RE 6031  
lx=108,78cm

RE 6203  
lx=82,43cm

RE 6030  
lx=65,04cm

RE 6202  
lx=25,95cm

RE 6021  
lx=4,47cm

RE 6020  
lx=2,57cm

RE 6029

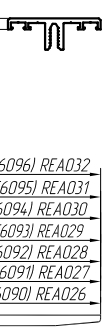
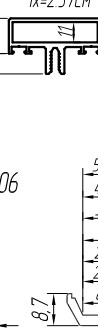
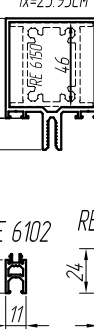
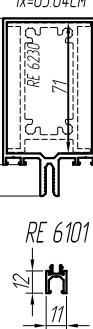
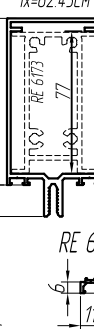
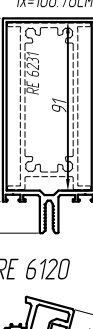
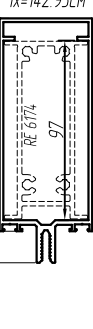
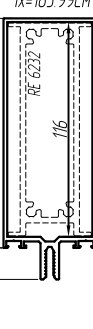
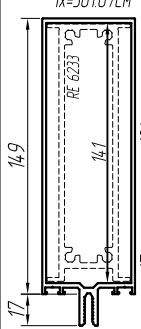

50 (RE6096) REA032
44 (RE6095) REA031
38 (RE6094) REA030
32 (RE6093) REA029
26 (RE6092) REA028
20 (RE6091) REA027
8 (RE6090) REA026

RE 6120

RE 6100

RE 6101

RE 6102

RE 6103

RE 6104

RE 6105

RE 6106

RE 6051

RE 6052

RE 6053

RE 6054

RE 6055

RE 6056

RE 6057

RE 6058

RE 6059

RE 6064

RE 6063

RE 6062

RE 6061

RE 6060

RE 6066

RE 6067

RE 6068

RE 6050

RE 6070

RE 6071

RE 6072

RE 6073

RE 6080

RE 6081

RE 6082

RE 6083

RE 6130

RE 7401

RE 7403

RE 6110

RE 6111

RE 6112

RE 6113

RE 6114

RE 6085

RE 6084

RE 6122

RE 6121

RE 6009  
lx=172,58cm

RE 6007  
lx=50,88cm

RE 6008  
lx=98,43cm

RE 6185

RE 6180

RE 6181

RE 6182

RE 6184

RE 50.087088

RE 50.089090

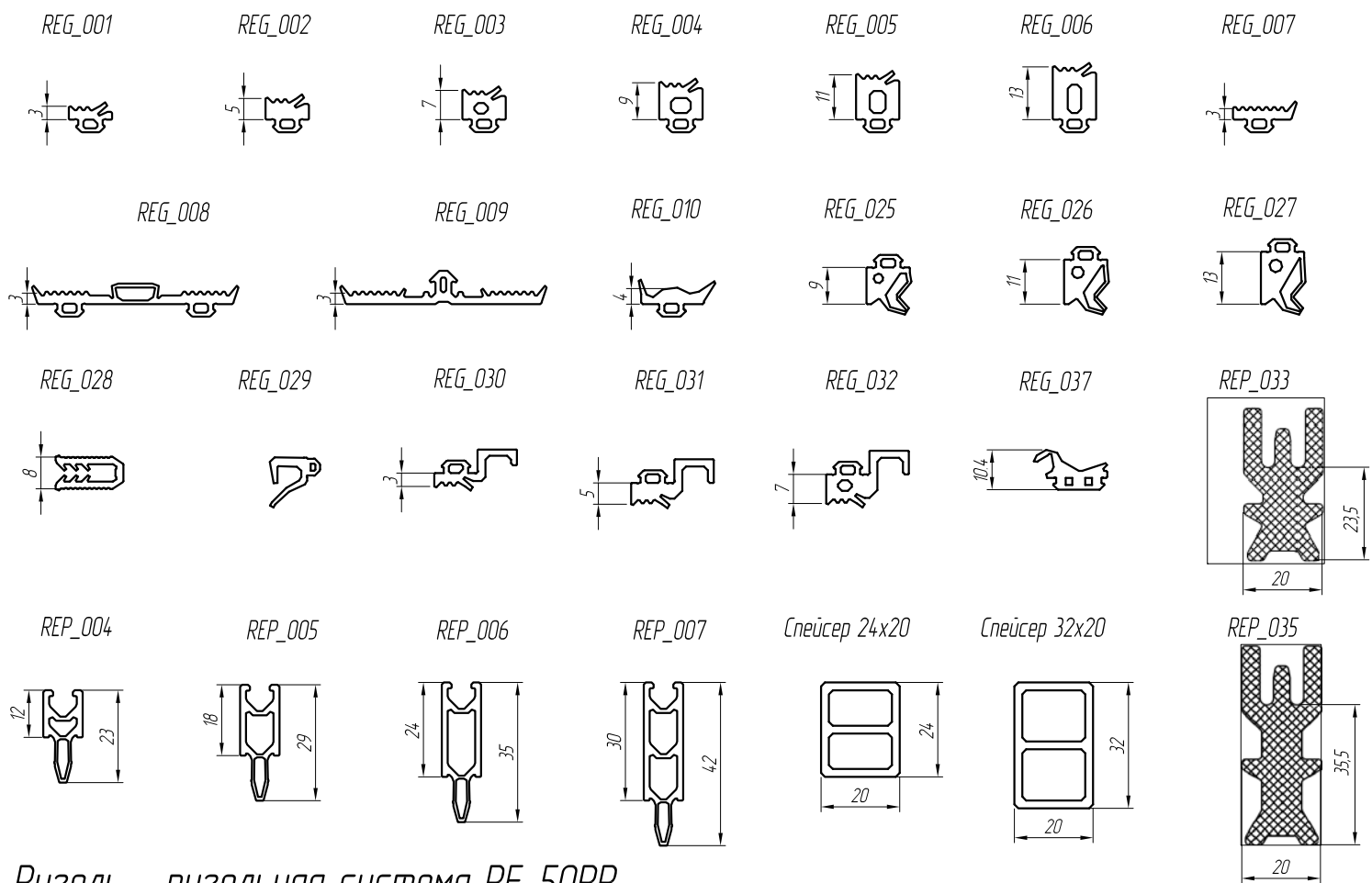

## Ригель – ригельная система RF-50RR

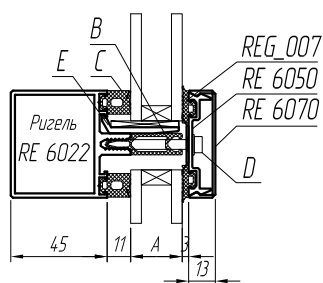
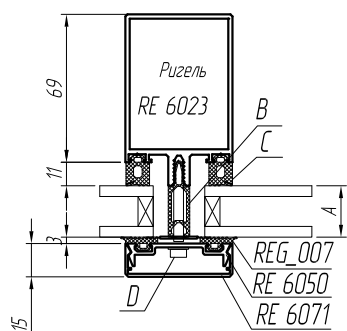

50 (RE6096) REA032
44 (RE6095) REA031
38 (RE6094) REA030
32 (RE6093) REA029
26 (RE6092) REA028
20 (RE6091) REA027
8 (RE6090) REA026

3	8	REA 033 3x8x100
3	20	REA 034 3x20x100
3	26	REA 035 3x26x100
3	32	REA 036 3x32x100

A	B	C	D
6мм	-	REG_002	5.5x20
24мм	REP_006	REG_005	5.5x44
32мм	REP_006	REG_001	5.5x44

A	B	C	D	E
6мм	-	REG_002	5.5x20	RE6090+REA 033
24мм	REP_006	REG_005	5.5x44	RE6093+REA 036
32мм	REP_006	REG_001	5.5x44	RE6093+REA 036

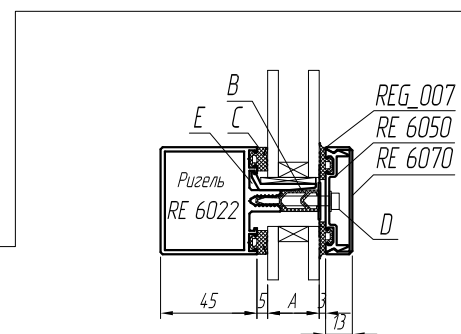

A	B	C	D	E
6мм	-	REG_002	5.5x20	RE6090+REA 033
24мм	REP_005	REG_002	5.5x38	RE6092+REA 035
32мм	REP_006	REG_001	5.5x44	RE6093+REA 036

## Стойчно – ригельная система RF-50

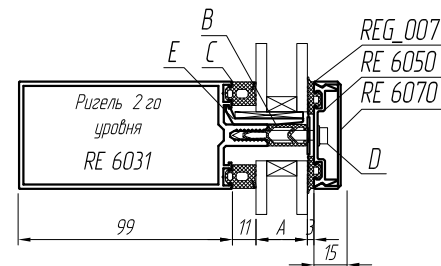
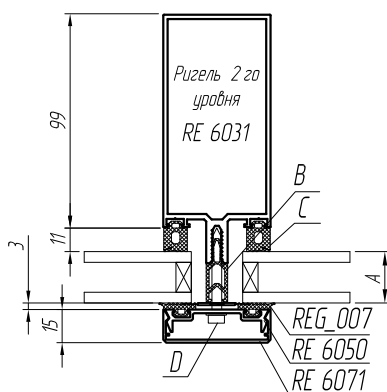
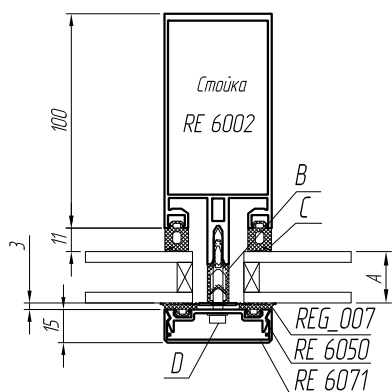

A	B	C	D
6мм	-	REG_005	5.5x20
24мм	REP_005	REG_005	5.5x38
32мм	REP_006	REG_004	5.5x44

A	B	C	D
6мм	-	REG_005	5.5x20
24мм	REP_005	REG_005	5.5x38
32мм	REP_006	REG_004	5.5x44

A	B	C	D	E
6мм	-	REG_005	5.5x20	RE6090+REA 033
24мм	REP_005	REG_005	5.5x38	RE6092+REA 035
32мм	REP_006	REG_004	5.5x44	RE6093+REA 036